

Ver.2024 - English

DENTAL INSTRUMENTS

MADE IN JAPAN



CONTENTS

ENDODONTICS

P.4

KSK Rubber Dam Clamps	P.4	RTP Reamers	P.21
Dental Dams	P.15	Finger Ruler	P.22
Rubber Dam Accessories	P.16	X-Ray Mesh Gauges	P.22
Rubber Dam Set	P.19	Resin Post Methacrylics	P.22
M Peeso Reamers	P.21	Retro Filling Retractor	P.23
Peeso Reamers	P.21	MTA carrier	P.23

PROSTHETICS

P.24

Matrix Bands	P.24	Tooth Contact Gauges	P.26
Matrix Retainer	P.24	New Inlay & Crown Setters	P.26
KSK Sectional Matrix Ring	P.25	Articulating Paper Holders	P.26
Tooth Separators	P.25	New Fine Lock Trays	P.27

IMPLANTOLOGY

P.28

Twist Drills Black	P.28	Drill Extenders	P.34
Step Drills For Guide	P.29	Drill Extension SHORT	P.34
Twist Drills For Guide	P.29	Technika Bone Mill Set	P.35
Twist Drills	P.30	Depth Gauges	P.35
Trephine Burs	P.31	Technika Repair Tap	P.36
Bone Trephines	P.31	Screw Remover	P.36
Circuler Knives	P.31	Gingiva Gauge	P.37
Surgical Burs	P.32	Bur Stands	P.37
Technika TK Drill System	P.33		
Multi-Adapter Wrench	P.33		
Implant Drill Checker	P.34		

LABORATORY

P.38

Vulcanite Burs	P.38	Air Jet Diamonds	P.38
----------------	------	------------------	------

MISCELLANEOUS

P.39

Lip & Cheek Retractor	P.39	pinlight2	P.42
Lip Expanders	P.39	Excavators	P.43
Big Oral Mirrors Real-Fine	P.40	Wax Spatulas 7A	P.43
Cotton Pliers	P.41	Evans	P.44
Tongue Guards & Saliva Ejector	P.41	Hollenback #3	P.44
Parallel Reflector	P.41	Woodson #1	P.44

Autoclavable



Up to 121°C for 15 min



Up to 132°C for 5 min



Non - autoclavable



Made-to-order items

ENDODONTICS

PROSTHETICS

IMPLANTOLOGY

LABORATORY

MISCELLANEOUS



KSK Rubber Dam Clamps



Features

- KSK Rubber Dam Clamps are made of specially selected and tempered stainless steel.
- Ideal spring action and high resistance against the corrosion.
- Various forms are available, so you can choose clamps in accordance with the teeth.
- 4000 times open-close metal fatigue test goes for every production lot to assure long-term spring action.
- For stable forms, our craftsmen adjust bending every KSK clamps one by one manually.
- All beaks are sharpened for best fitting on the teeth.
- "MATT" and "BLACK" can avoid eye fatigue of dentists from reflecting operation light.

Finishing



GLOSSY
Glossy finishing.



MATT
Sand blasted non glossy finishing.



BLACK
Not painted, Oxide layer finishing which is safe for human body

Winged or Wingless

WINGED

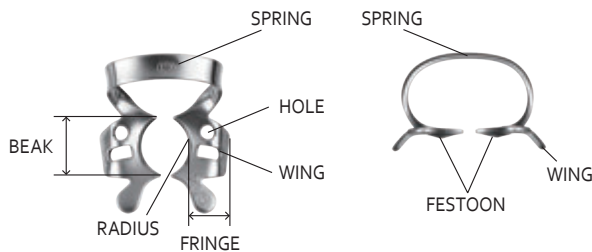

WINGLESS

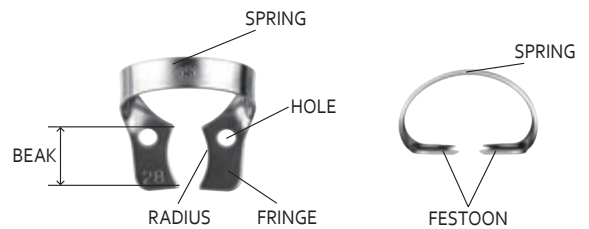

[Important Safety Instructions]

It is likely to transform and to break when force is excessively added.
Please do not expand rubber dam clamps more than the necessity.

KSK Rubber Dam Clamps

Molar Clamps

Product Code

- Glossy
- Matt
- Black

3

- 01012003
- 01014003
- 01019003

For small lower molars with flat beaks.

W3

- 01012903
- 01014903
- 01019903

For small lower molars with flat beaks. Similar to 3 but wingless.

4

- 01012004
- 01014004
- 01019004

For upper molars with festooned beaks.

5

- 01012005
- 01014005
- 01019005

For upper molars with festooned beaks.

7

- 01012007
- 01014007
- 01019007

For big lower molars with flat beaks.

7A

- 01012907
- 01014907
- 01019907

For big lower molars with flat beaks.

8

- 01012008
- 01014008
- 01019008

For big upper molars with festooned beaks. Same size as 7.

8A

- 01012908
- 01014908
- 01019908

For upper molars with deeply festooned beaks which can grab subgingival part.

ENDODONTICS

PROSTHETICS

IMPLANTOLOGY

LABORATORY

MISCELLANEOUS



ENDODONTICS

Molar Clamps

Product Code

- Glossy
- Matt
- Black

W8A

- 01012998
- 01014998
- 01019998

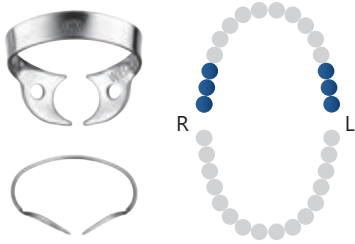

Similar to 8A but wingless.

12A

- 01012912
- 01014912
- 01019912

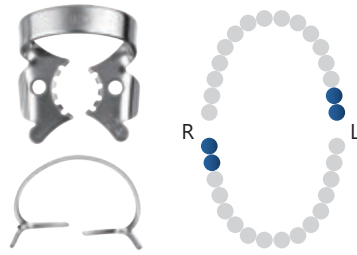

Especially for the third upper left and lower right molars with flat serrated beaks, paired with 13A.

13A

- 01012913
- 01014913
- 01019913

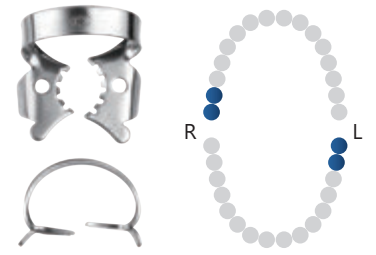

Especially for the third lower left and upper right molars with flat serrated beaks, paired with 12A.

14

- 01012014
- 01014014
- 01019014

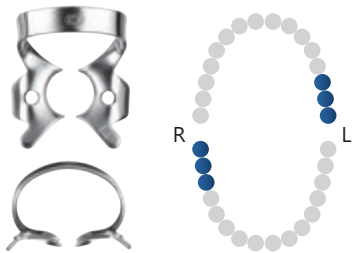

For partially erupted molars with deeply festooned beaks.

14A

- 01012914
- 01014914
- 01019914

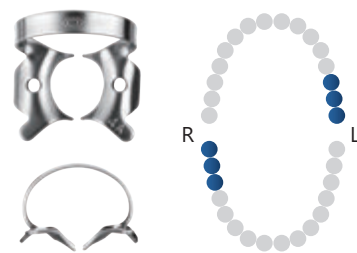

For partially erupted molars with deeply festooned beaks, bigger than 14.

15

- 01012015
- 01014015
- 01019015

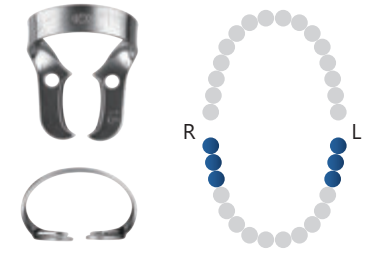

For big lower molars with flat and longer beaks, a strong spring.

18

- 01012018
- 01014018
- 01019018

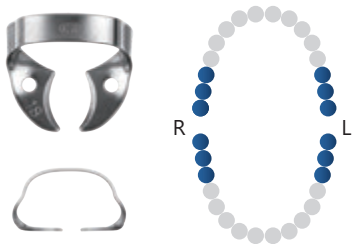

For upper & lower molars with flat beak.

24

- 01012024
- 01014024
- 01019024

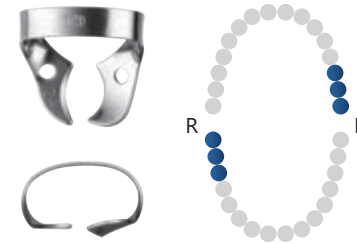

For upper left and lower right buccal molars' subgingival cavities. The buccal side has wider fringe slightly festooned beaks. Paired with 25.

25

- 01012025
- 01014025
- 01019025

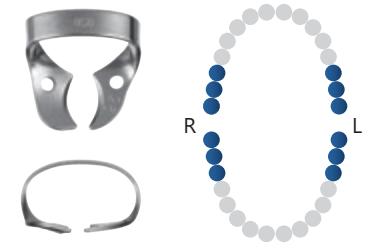

For lower left and upper right buccal molars' subgingival cavities. The buccal side has wider fringe slightly festooned beaks. Paired with 24.

ENDODONTICS

PROSTHETICS

IMPLANTOLOGY

LABORATORY

MISCELLANEOUS

Molar Clamps

Product Code | Glossy
 Matt
 Black

26

- 01012026
- 01014026
- 01019026

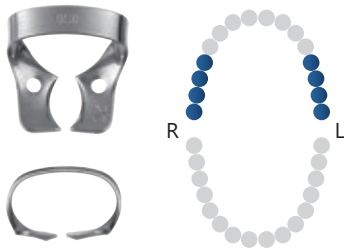

For upper molars in case of exposure of the tooth neck with slightly festooned beaks. Available for the second bicuspids.

28

- 01012028
- 01014028
- 01019028

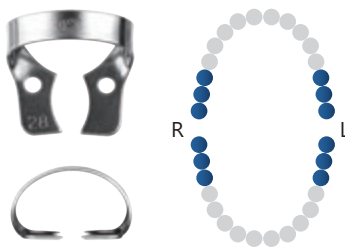

For upper and lower molars with flat beaks, wide view.

30

- 01012030
- 01014030
- 01019030

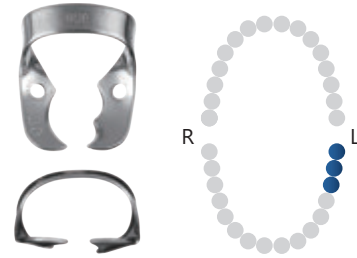

For lower left molar subgingival with slightly festooned beaks. The projection on the buccal beak slips into the furcation. Paired with 31.

31

- 01012031
- 01014031
- 01019031

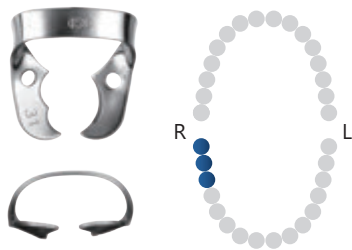

For lower right molar subgingival with slightly festooned beaks. The projection on the buccal beak slips into the furcation. Paired with 30.

42

- 01012042
- 01014042
- 01019042

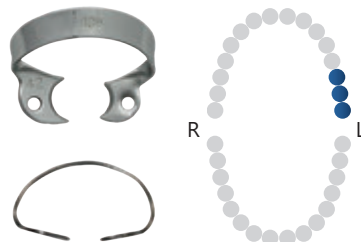

For upper left molars with flat beaks, paired with 43.

43

- 01012043
- 01014043
- 01019043

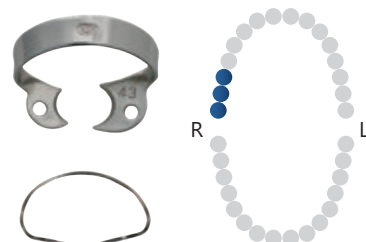

For upper right molars with flat beaks, paired with 42.

51

- 01012051
- 01014051
- 01019051

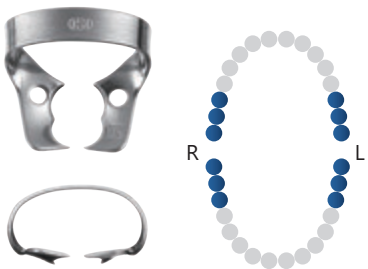

For buccolabial molar furcations with slightly festooned beaks. Enables to press down the gingiva.

56

- 01012056
- 01014056
- 01019056

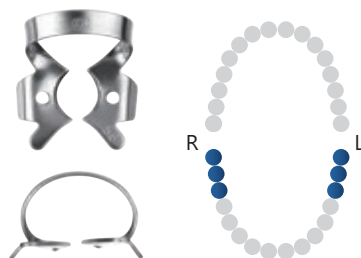

For lower molars with with festooned beaks.

56A

- 01012956
- 01014956
- 01019956

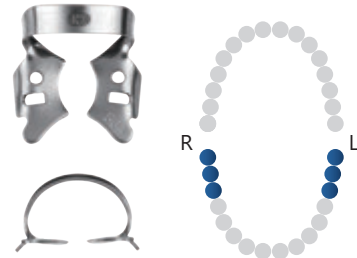

For big lower molars with very slightly festooned beaks. One size larger than 56.

ENDODONTICS

PROSTHETICS

IMPLANTOLOGY

LABORATORY

MISCELLANEOUS



ENDODONTICS

Molar Clamps

Product Code

- Glossy
- Matt
- Black

U67

- 01012067
- 01014067
- 01019067

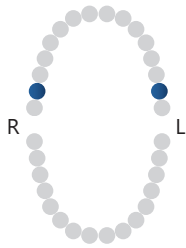

Best for upper second molars with festooned beaks, compact size.

138

- 01012138
- 01014138
- 01019138

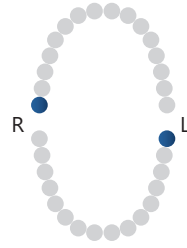

For upper right and lower left third molars with serrated offset beaks, paired with 139.

139

- 01012139
- 01014139
- 01019139

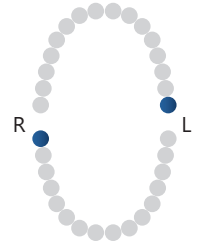

For upper left and lower right third molars with serrated offset beaks, paired with 138.

201

- 01012201
- 01014201
- 01019201

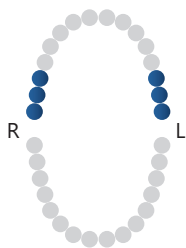

For upper molars with slightly festooned beaks.

202

- 01012202
- 01014202
- 01019202

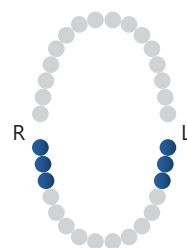

For big lower molars with flat beaks. A little bigger than 200.

203

- 01012203
- 01014203
- 01019203

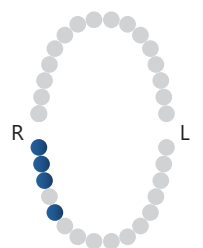

For lower right molars and the first bicuspid with flat beaks, Paired with 204.

204

- 01012204
- 01014204
- 01019204

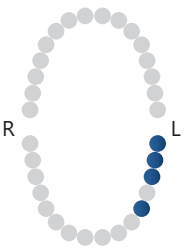

For lower left molars and the first bicuspid with flat beaks, Paired with 203.

205

- 01012205
- 01014205
- 01019205

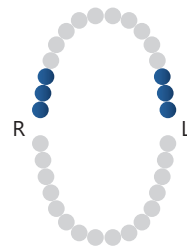

For upper molars with very slightly festooned beaks.

G-1

- 50580002
- 50550010
- 50550030

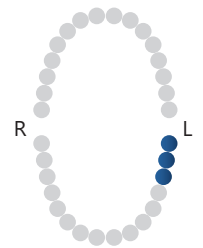

For lower left molars with cheek and tongue pressure shoving wings. No need to wear dental dam but gauze or cotton rolls. Paired with G-2.

ENDODONTICS

PROSTHETICS

IMPLANTOLOGY

LABORATORY

MISCELLANEOUS

Molar Clamps

Product Code | ■ Glossy | ■ Matt | ■ Black

G-2 ■ 50580003
■ 50550011
■ 50550031

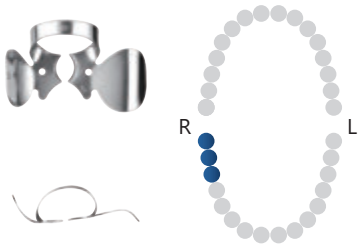

For lower right molars with cheek and tongue pressure showing wings. No need to wear dental dam but gauze or cotton rolls. Paired with G-1.

DISTAL ■ 50030000

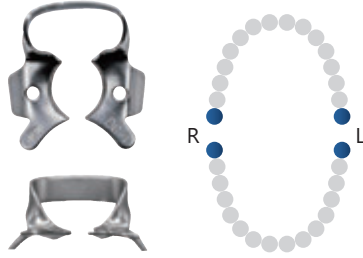

Available for molars, both deciduous and permanent easy to reach distal part of molar.

KSK Rubber Dam Clamps

Bicuspid Clamps

Product Code
■ Glossy
■ Matt
■ Black

0 ■ 01012701
■ 01014701
■ 01019701

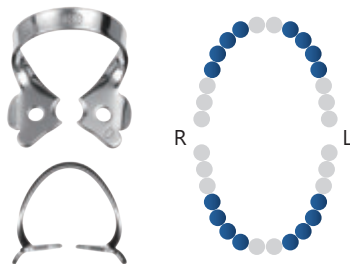

For narrow bicuspid cervical zone with flat beaks. Available for deciduous anteriors as well.

00 ■ 01012702
■ 01014702
■ 01019702

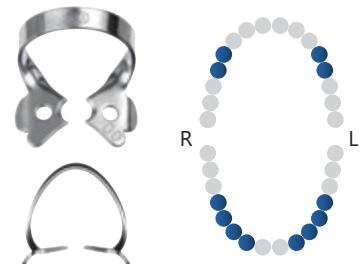

For small bicuspid with flat beaks. Available for deciduous anteriors as well.

1 ■ 01012001
■ 01014001
■ 01019001

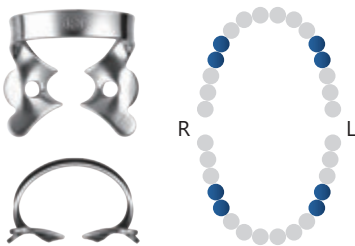

For bicuspid root with festooned beaks.

1A ■ 01012901
■ 01014901
■ 01019901

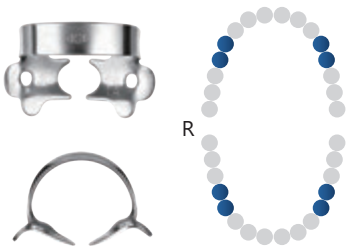

For cervical cavities of bicuspid with festooned beaks.

2 ■ 01012002
■ 01014002
■ 01019002



For lower bicuspid with flat beaks.

ENDODONTICS

PROSTHETICS

IMPLANTOLOGY

LABORATORY

MISCELLANEOUS



ENDODONTICS

Bicuspid Clamps

Product Code

- Glossy
- Matt
- Black

2A

- 01012902
- 01014902
- 01019902

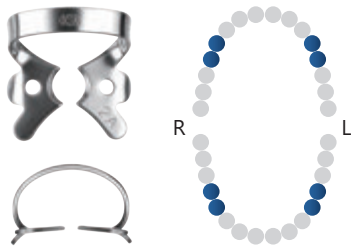

For bigger upper and lower bicuspid with flat beaks. A little bigger than 2.

W2A

- 01012992
- 01014992
- 01019992

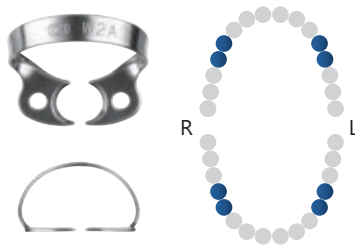

Similar to 2A but wingless.

22

- 01012022
- 01014022
- 01019022

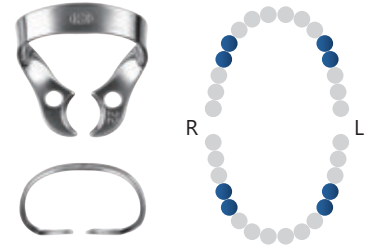

For upper and lower bicuspid with flat beaks, similar to 207 but wingless.

27

- 01012027
- 01014027
- 01019027

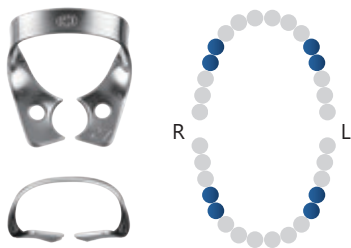

For upper and lower bicuspid with festooned beaks, similar to 206 but wingless.

29

- 01012029
- 01014029
- 01019029

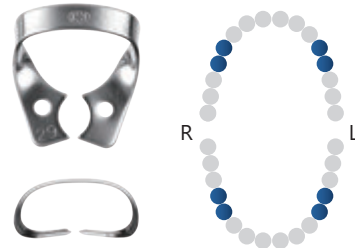

For upper and lower bicuspid with flat beaks, for wider view.

206

- 01012206
- 01014206
- 01019206

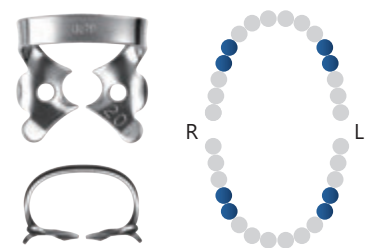

For upper and lower bicuspid with festooned beaks. Similar to 27 but winged.

207

- 01012207
- 01014207
- 01019207

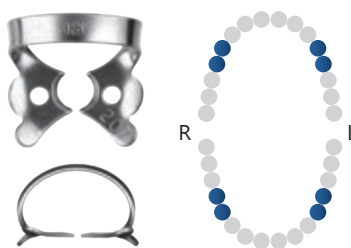

For upper and lower bicuspids with flat beaks. Similar to 22 but winged.

208

- 01012208
- 01014208
- 01019208

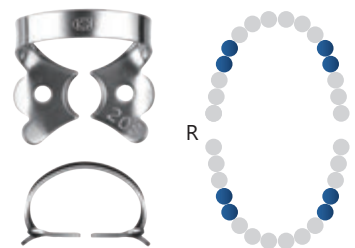

For big bicuspid. Similar to 207 but the fringe is little bigger.

209

- 01012209
- 01014209
- 01019209

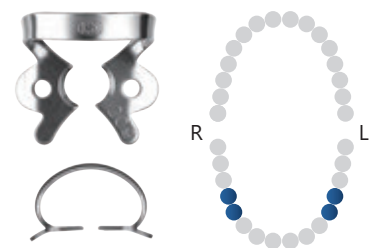

For lower bicuspid with flat beaks. Similar to 208 but a little smaller and stronger spring.

ENDODONTICS

PROSTHETICS

IMPLANTOLOGY

LABORATORY

MISCELLANEOUS

Labial Clamps

Product Code | Glossy
 Matt
 Black

Y10 01014999

For Pre-molar, Deep festooned beaks grab subgingival part, Wingless of No.1.

KSK Rubber Dam Clamps

Labial Clamps

Product Code
 Glossy
 Matt
 Black

6 01012006
01014006
01019006

For anteriors with slightly offset beaks.

9 01012009
01014009
01019009

For labial cavities on anteriors with slightly offset beaks.

44 01012044
01014044
01019044

For anteriors cuspid and cavities with flat beaks.

90N 01012090
01014090
01019090

Offset beaks and stronger spring.

210 01012210
01014210
01019210

For anteriors labial and canines and cavities on bicuspid labial .

212 01012212
01014213
01019214

For gum compression on anteriors with offset beaks.

212 SA 01018212
01018213
01018214

Similar to 212 but a little stronger pressure to gingiva.

ENDODONTICS
 PROSTHETICS
 IMPLANTOLOGY
 LABORATORY
 MISCELLANEOUS



ENDODONTICS

Deciduous Clamps

Product Code

- Glossy
- Matt
- Black

KSK Rubber Dam Clamps

Deciduous Clamps

Product Code

- Glossy
- Matt
- Black

54 01015001

For upper right the first deciduous molars. (B/54)

55 01015002

For upper right the second deciduous molars. (A/55)

64 01015003

For upper left the first deciduous molars. (I/64)

65 01015004

For upper left the second deciduous molars. (J/65)

74 01015005

For lower left the first deciduous molars. (L/74)

75 01015006

For lower left the second deciduous molars. (K/75)

84 01015007

For lower right the first deciduous molars. (S/84)

85 01015008

For lower right the second deciduous molars. (T/85)

ENDODONTICS

PROSTHETICS

IMPLANTOLOGY

LABORATORY

MISCELLANEOUS

Deciduous Clamps

Product Code | Glossy
 Matt
 Black

P-1

- 50580000
- 50550000
- 50550020

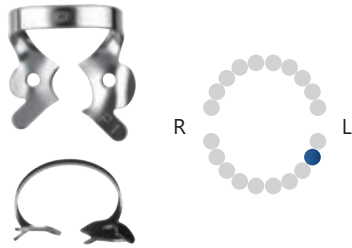

For lower left the first deciduous molars. (L/74)
Paired with P-2.

P-2

- 50580001
- 50550001
- 50550021

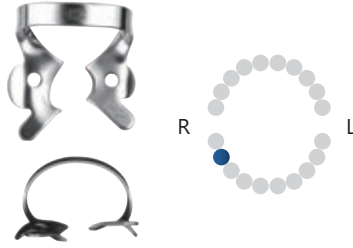

For lower right the first deciduous molars. (S/84)
Paired with P-1.

ENDODONTICS

PROSTHETICS

IMPLANTOLOGY

LABORATORY

MISCELLANEOUS



ENDODONTICS

ENDODONTICS

PROSTHETICS

IMPLANTOLOGY

LABORATORY

MISCELLANEOUS

KSK Rubber Dam Clamps
Tiger Clamps

Product Code
■ Glossy
■ Matt
■ Black

1T

01012501
01014501
01019501

For bicuspid root with festooned serrated beaks.

1AT

01012502
01014502
01019502

For bicuspids, especially for subgingival cavities with deeply festooned serrated beaks.

2T

01012503
01014503
01019503

For lower bicuspids with flat serrated beaks.

2AT

01012504
01014504
01019504

For upper and lower bigger bicuspids with flat serrated beaks. A little bigger than 2T

9T

01012505
01014505
01019505

Used for labial cavities on anteriors with offset serrated beaks.

14T

01012506
01014506
01019506

For partially erupted molars with serrated deeply festooned beaks.

56T

01012507
01014507
01019507

For lower molars with festooned beaks.

Dental Dams

Dental Dams (Powder-Free)

Features

- KSK dental dams have a good resistance and elastic property.
- Pure natural rubber.
- "Thin" is made of color free material then capable for monitoring the condition of an patient during isolation treatment.

[Specification]

Packaging : 36 sheets / pack Size : 6" x 6" (152mm x 152mm)
 Thickness : apx 0.20mm(Medium), apx 0.18mm(Thin)
 Color : Green(Medium), Ivory(Thin)
 Scent : Non

Product Code 01023060

Product KSK Dental Dam Medium (cut)6"x6"

Product Code 01023070

Product KSK Dental Dam Thin (cut)6"x6"

Medium

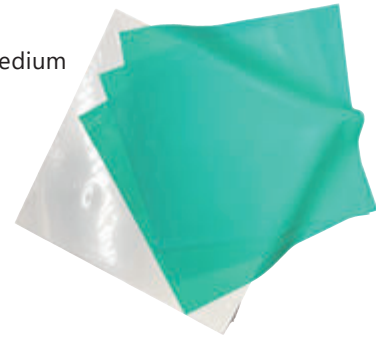

Thin



Dental Dam Non-Latex

Features

- Used when there is a concern regarding an individual's possible allergic reaction to the proteins present in natural rubber.

[Specification]

Packaging : 20 sheets / pack Size : 6" x 6" (152mm x 152mm)
 Thickness : 0.20mm Color : Blue Scent : Non

Product Code 01023040

Product KSK Dental Dam (cut)6"x6" Non-Latex



Dental Dam Non-Latex Powder-Free

Features

- Powder-free minimizes the risk of illness or injury caused by allergy for all dental health care personnel and patients.

[Specification]

Packaging : 15 sheets / pack Size : 6" x 6"(152mm x 152mm)
 Thickness : 0.25mm Color : Purple Scent : Mint

Product Code 01023050

Product KSK Dental Dam (cut)6" x 6" Non-Latex Powder-Free



ENDODONTICS

PROSTHETICS

IMPLANTOLOGY

LABORATORY

MISCELLANEOUS



Rubber Dam Accessories

KSK Rubber Dam Punch



[Specification] _____
Material : Stainless steel
Size : 153 x 70mm
Type : Ainsworth type.
Hole diameter : 1.4mm , 1.6mm , 1.8mm , 2.1mm , 2.3mm

Product Code 01021011
Product KSK Rubber Dam Punch



KSK Rubber Dam Clamp Forceps



Features

Original design of DENTECH Rubber Dam Clamps are automatically off from the forceps at the place of operator fits them on tooth.

[Specification] _____
Material : Stainless steel
Size : 165 x 70mm

Product Code 01031040
Product KSK Rubber Dam Clamp Forceps



Rubber Dam Frames Young Type



[Specification] _____
Material : Stainless steel
Adult : 108(w) x 95mm(h)
Pedo : 77(w) x 73mm(h)

Product Code 01022010
Product Rubber Dam Frame, Adult

Product Code 01022020
Product Rubber Dam Frame, Pedo

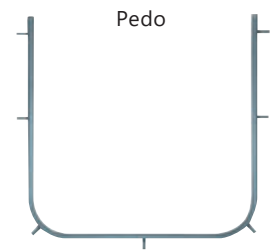
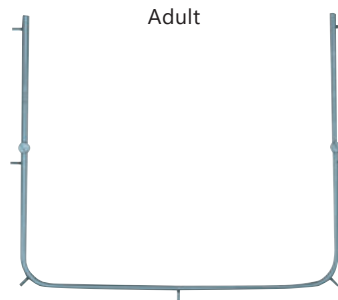

Rubber Dam Template

Features

For marking punch holes.

[Specification] _____
Material : Plastic
Size : 150 x 150mm

Product Code 08190020
Product Rubber Dam Template



Clamp set



Matt & Black

Clamp set No.8

[Specification]

Material : Stainless steel Size : 90 x 90mm

With 8 clamps : #9 x 2, 2A, W2A, 5, 56, 203 & 204 or Clamp Organizer (Board only)

Product Code 01041000 Product Clamp Organizer

Product Code 01040000 Product Glossy

Product Code 01040080 Product Matt

Product Code 01040050 Product Black



Clamp set No.12

[Specification]

Material : Stainless steel Size : 150 x 90mm

With 12 clamps : #210, 9, 0, 2, 2A, 206, 207, 5, 56, 7, 201 & 202 or Clamp Organizer (Board only)

Product Code 01041010 Product Clamp Organizer

Product Code 01040010 Product Glossy

Product Code 01040090 Product Matt

Product Code 01040060 Product Black



Clamp set No.18

[Specification]

Material : Stainless steel Size : 160 x 120mm

With 18 clamps : #210, 9, P-1, P-2, 22, 27, 29, 208, 209, 18, 138, 139, 7, 201, 202, 203, 204 & 205 or Clamp Organizer (Board only)

Product Code 01041020 Product Clamp Organizer

Product Code 01040020 Product Glossy

Product Code 01040100 Product Matt

Product Code 01040070 Product Black





Deciduous Clamp set

[Specification]

Material : Stainless steel Size : 90 x 90mm

Complete kit of 8 patterns with special Clamp board.

#55-upper right E #54-upper right D #64-upper left D #65-upper left E
#85-lower right E #84-lower right D #74-lower left D #75-lower left E

Product Code 01041061 Product Clamp Organizer

Product Code 01041070 Product Matt



Clamp set with cassette

[Specification]

Material : Stainless steel Size : 94 x 94 x 34 mm

Clamp set No.8 or Deciduous Clamp set with sterilization cassette

Product Code 01040001 Product No.8, Glossy

Product Code 01040081 Product No.8, Matt

Product Code 01040051 Product No.8, Black

Product Code 01041071 Product Deciduous, Matt



Rubber Dam Set



Matt & Black



Rubber Dam Technic set

[Specification]

Contents : ① Clamp set No.12

② Rubber Dam Frame Large(Adult)

③ Rubber Dam Punch(Ainsworth)

④ Rubber Dam Clamp Forceps

Clamps : #210, #9, #0, #2, #2A, #206, #207, #5, #56, #7, #201, #202

Product Code 01030100 Product Glossy

Product Code 01030120 Product Matt

Product Code 01030110 Product Black

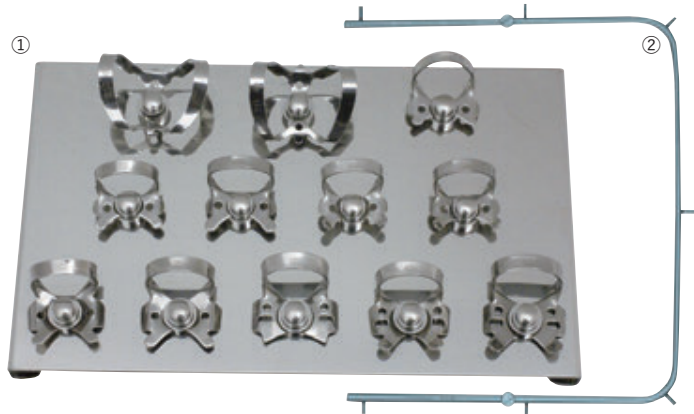

Rubber Dam Complete set

[Specification]

Material : Stainless steel Size : 274 x 184 x 34 mm

Rubber Dam Technic set with with sterilization cassette

Product Code 01030101 Product Glossy

Product Code 01030121 Product Matt

Product Code 01030111 Product Black

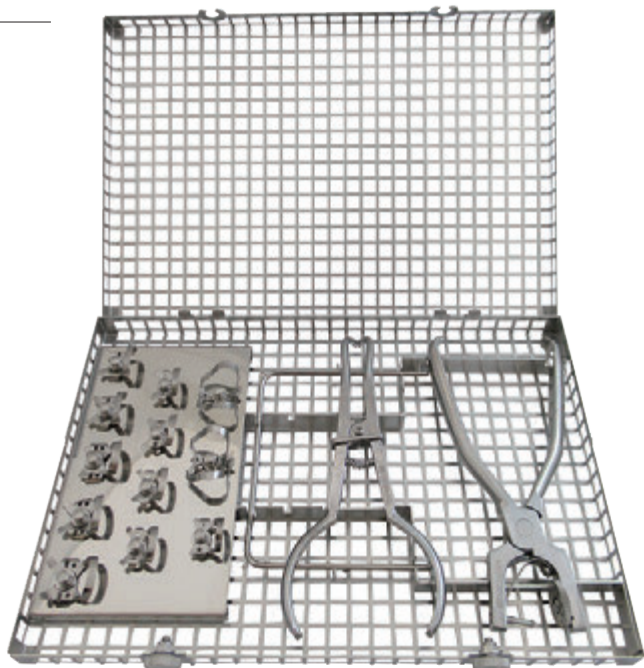



Rubber Dam Starter Kit

[Specification]

Basic assortment for rubberdam technique

- Contents :
- ① Clamp set No.12,
 - ② Rubber Dam Frame(Adult)
 - ③ KSK Rubber Dam Punch(Ainsworth)
 - ④ KSK Rubber Dam Clamp Forceps
 - ⑤ KSK Dental Dam Non-Latex Blue(20 sheets)
 - ⑥ Rubber Dam Template

Product Code **01030130** Product **Glossy**

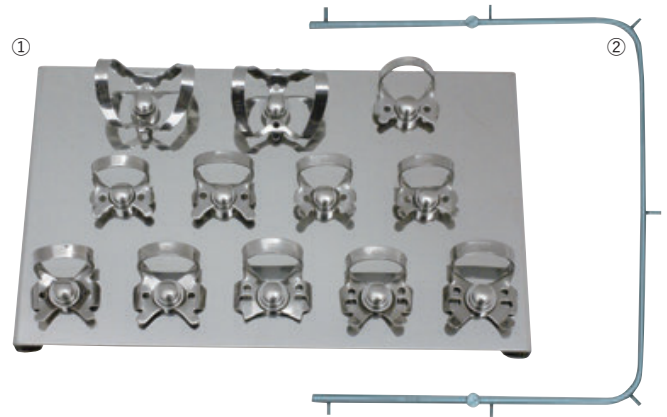

*Dental Dam : not autoclavable

Sterilization Cassette

Description

- Ultra light
- For washing, sterilization and storage

[Specification]

Material : Stainless steel

S : 94 x 94 x 34mm

L : 274 x184 x34mm

S for KSK Clamp set No.8 & KSK Deciduous Clamp set

L for KSK Rubber Dam Technic set

Product Code **50710605**

Product **Sterilization Cassette S**

Product Code **50710610**

Product **Sterilization Cassette L**

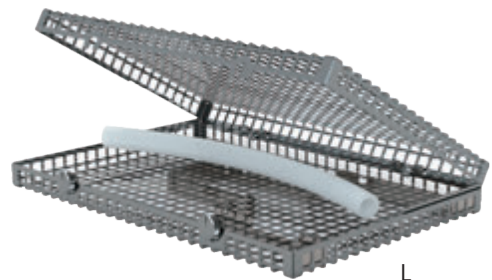
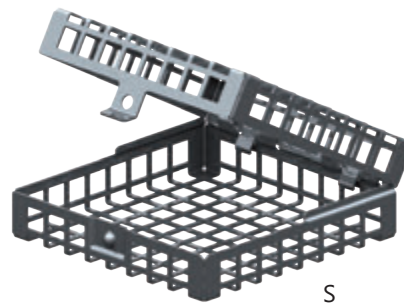

M Peeso Reamers

[Specification]

Material : Stainless steel
 Sharp shaped top
 Pilot hole drills for root canal treatment.



Product Code	02312200	Product	M Peeso Reamer CA #000 (set of 4 pcs)
Product Code	02312201	Product	M Peeso Reamer CA #00 (set of 4 pcs)
Product Code	02312202	Product	M Peeso Reamer CA #0 (set of 4 pcs)
Product Code	02312203	Product	M Peeso Reamer CA #1 (set of 4 pcs)
Product Code	02312204	Product	M Peeso Reamer CA #2 (set of 4 pcs)
Product Code	02312205	Product	M Peeso Reamer CA #3 (set of 4 pcs)

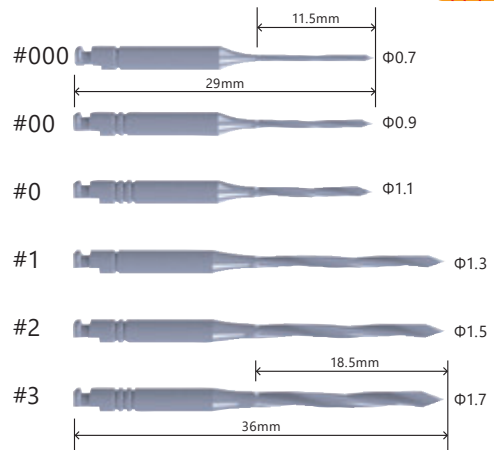

Peeso Reamers

[Specification]

Material : Stainless steel
 Round shaped top
 Pilot hole drills for root canal treatment.



Product Code	02312000	Product	Peeso Reamer CA #000 (set of 4 pcs)
Product Code	02312001	Product	Peeso Reamer CA #00 (set of 4 pcs)
Product Code	02312002	Product	Peeso Reamer CA #0 (set of 4 pcs)
Product Code	02312003	Product	Peeso Reamer CA #1 (set of 4 pcs)
Product Code	02312004	Product	Peeso Reamer CA #2 (set of 4 pcs)
Product Code	02312005	Product	Peeso Reamer CA #3 (set of 4 pcs)

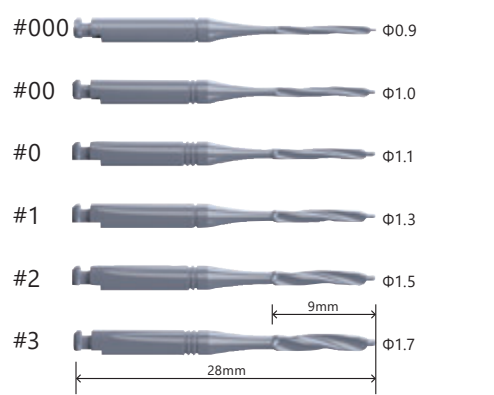

RTP Reamers

[Specification]

Material : Stainless steel
 Round shaped
 Final drills for root canal treatment.



Product Code	02312100	Product	RTP Reamer #1 (set of 4 pcs)
Product Code	02312101	Product	RTP Reamer #2 (set of 4 pcs)
Product Code	02312102	Product	RTP Reamer #3 (set of 4 pcs)

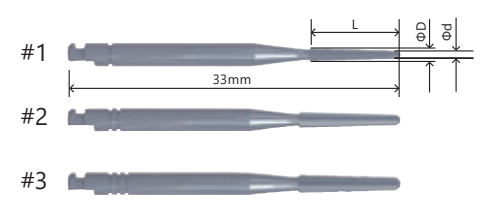

	mm		
	L	φD	φd
# 1	9	1.35	0.92
# 2	10	1.65	1.17
# 3	10	1.95	1.48

ENDODONTICS

PROSTHETICS

IMPLANTOLOGY

LABORATORY

MISCELLANEOUS



Finger Ruler

Description

Can be attached on finger by free size. The adjustable stopper keeps it's position by spring.

[Specification]

Material : Stainless steel Measurement length : 32mm

Product Code 03050000

Product Finger Ruler

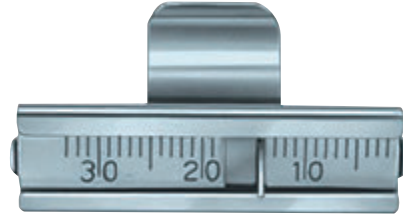

X-Ray Mesh Gauge

Description

Suitable for root canal treatment. Accurate examination before placing an implant. checking of calculus quantity and its area.

[Specification]

Cover Material : Polyester Mesh Line Material : Stainless steel

●Dental Size

Size : 40 x 30mm Fine Grid : pitch 1mm Wide Grid : pitch 5mm

Product Code 07050010

Product X-Ray Mesh Gauge, Dental

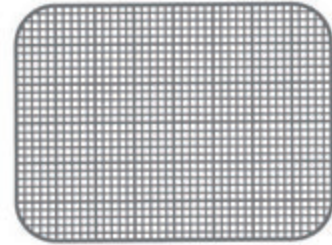

Resin Post Methacrylics

Description

You use the core build upon by the indirect method. It disappears, becomes gas when casting. For the post of the same size and RTP reamer, post selection is easy.

[Specification]

Fine plastic burn - out posts.

Indirect only

Product Code 05000050

Product Resin Post Methacrylic #R1 (set of 50 pcs)

Product Code 05000051

Product Resin Post Methacrylic #R2 (set of 50 pcs)

Product Code 05000052

Product Resin Post Methacrylic #R3 (set of 50 pcs)

#R1(Blue)



#R2(Yellow)



#R3(Red)



Retro Filling Retractor

Description

For reverse root canal treatment, Autoclavable

[Specification]

Material : Stainless steel Measurement length : 176mm

Product Code 30600600

Product Retro Filling Retractor #1



MTA Carrier

Description

- Thin and long pipe suck up MTA and delivers into narrow and deep root canal.
- "Wide" suck up four times as amount as the existing product.
- Delicate Tip is designed to be replaceable in case of damaged.
- The handle is made of aluminum, light and making it easy to work with.

[Specification]

Overall length : 140mm

Tip outer diameter : Spare Parts ϕ 0.8mm, Wide ϕ 1.4mm

Material : Stainless (Carrier Parts), Aluminum (Handle)

Spare Parts contain Pipe and Extrude Bar 1each

Spare Parts Wide is optionally available.

Product Code 01060003

Product MTA carrier

Product Code 01060013

Product MTA carrier Spare Parts

Product Code 01060032

Product MTA carrier Spare Parts Wide



Spare Parts Wide

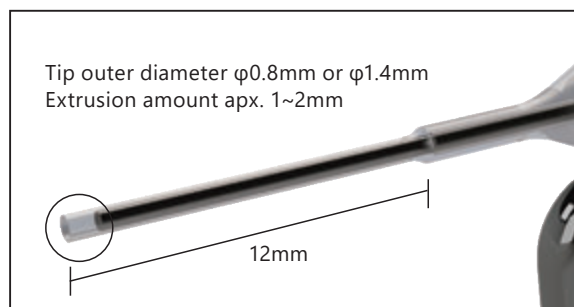



Matrix Bands



Matrix Bands

[Specification]
Material : Stainless Steel Thickness : 0.04mm

Product Code	04021101	Product	Matrix Bands #A (set of 100 pcs)
Product Code	04021102	Product	Matrix Bands #B (set of 100 pcs)
Product Code	04021103	Product	Matrix Bands #C (set of 10 pcs)
Product Code	04021104	Product	Matrix Bands #D (set of 10 pcs)
Product Code	04021105	Product	Matrix Bands #E (set of 10 pcs)
Product Code	04021106	Product	Matrix Bands #F (set of 10 pcs)
Product Code	04021107	Product	Matrix Bands #G (set of 10 pcs)
Product Code	04021108	Product	Matrix Bands #H (set of 10 pcs)
Product Code	04021109	Product	Matrix Bands #I (set of 100 pcs)
Product Code	04021110	Product	Matrix Bands #J (set of 100 pcs)

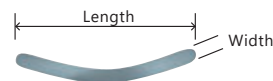
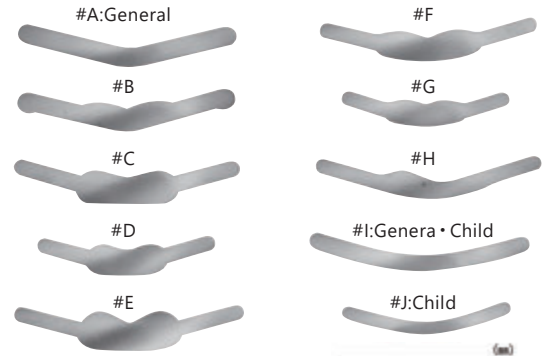

TYPE	Length	Width
A	63	6
B	63	7.6
C	65	8
D	51	5
E	66	5
F	64	5
G	49	4.5
H	64	4.5
I	64	5
J	50	4

※ Matrix Band #B-H is for sale while stock lasts.

T Bands

Description
Can be used without the Matrix Retainer.

[Specification]
Material : Stainless Steel Thickness : 0.04mm

Product Code	04023111	Product	T Bands, Large (set of 100 pcs)
Product Code	04023112	Product	T Bands, Small (set of 100 pcs)

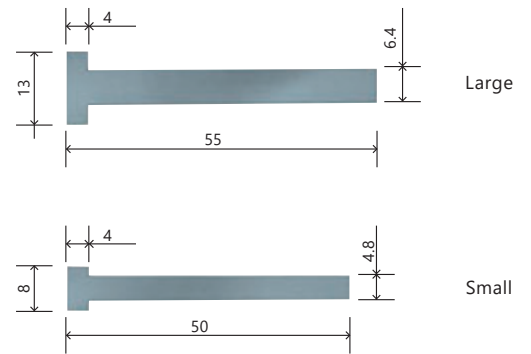

How to use T Bands

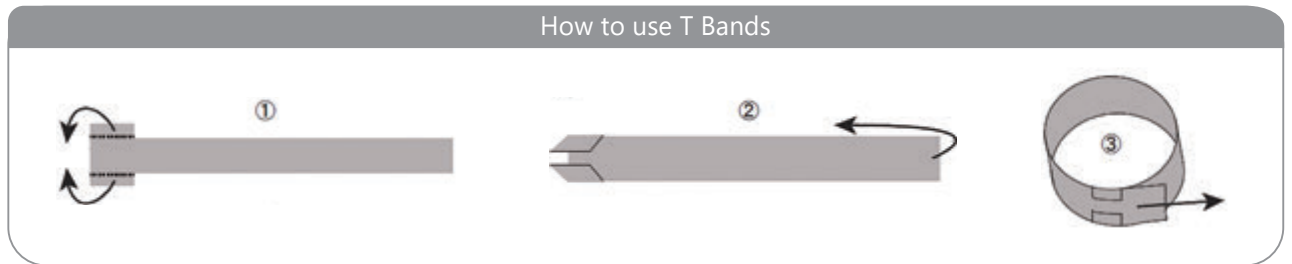

Matrix Retainer #9-T Tofflemire



Description
By a screw that has been improved, it will be a fine movement smooth.

[Specification]
Material : Stainless Steel Size : 64mm

Product Code	04019200
Product	Matrix Retainers Tofflemier Type, Universal Adult, 9-T



ENDODONTICS

PROSTHETICS

IMPLANTOLOGY

LABORATORY

MISCELLANEOUS

KSK Sectional Matrix Ring

Description

- Rings used to hold the matrix in right place on the teeth.
- Simple nail design works with a variety of teeth.
- Available with your clamp forceps.
- Spring force is just right and easy to adjust.

[Specification]

Material : Stainless Steel

Product Code 06000010

Product KSK Sectional Matrix Rings 2 pcs

Product Code 06000020

Product KSK Sectional Matrix Rings set with Forceps



ENDODONTICS

PROSTHETICS

Tooth Separators

Elliot's Separator

Description

The pushing screw can be attached both right and left side. Improved jaw design enable to be stable while pushing by the screw.

[Specification]

Material : Stainless Steel

Size : 37 x 67mm

Product Code 01071000

Product Elliot's Separator

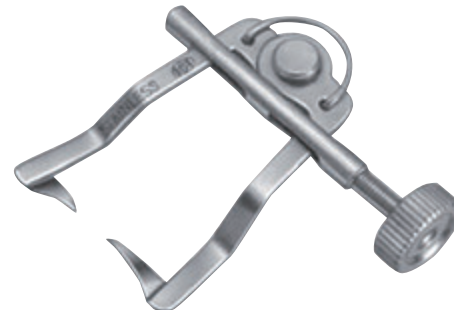

IMPLANTOLOGY

LABORATORY

Ivory's Separator

Description

With improved curved jaw design, thus separators become stable while pushing by the screw. It is applied in the front area of the upper and lower teeth.

[Specification]

Material : Stainless Steel

Size : 37 x 67mm

Product Code 01072000

Product Ivory's Separator



MISCELLANEOUS



Tooth Contact Gauges



Description

For checking interdental contact points.
In three colour coded thicknesses.

[Specification]

Material : Stainless Steel

Holder size:130 x 22 mm

Thickness: Blue 0.05 mm, Yellow 0.11 mm, Red 0.15 mm

Set: Holder x 1pc, Blue Gauges x 3pcs, Yellow Gauge x 1pc, Red Gauge x 1pc

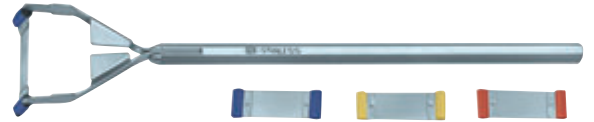

Product Code 50050020
Product Tooth Contact Gauge Set

Product Code 50050022
Product Tooth Contact, Refill Gauge Yellow (0.11mm)

Product Code 50050021
Product Tooth Contact, Refill Gauge Blue (0.05mm)

Product Code 50050023
Product Tooth Contact, Refill Gauge Red (0.15mm)

New Inlay & Crown Setters



[Specification]

Material : Stainless steel and silicone rubber

Long handle for molars has short pushing pin(SIZE : 79 x 24mm)

Short handle for bicuspid has long pushing pin (SIZE : 69 x 24mm)

Silicone rubber :
Dry heat are prohibited

Product Code 06092300
Product New Inlay & Crown Setter Set

Product Code 06092310
Product New Inlay & Crown Setter L Set

Product Code 06092320
Product New Inlay & Crown Setter S Set

Product Code 50050035
Product New Inlay & Crown Setter, Extra Rubber Pads 2 pcs



※Replacement silicone rubber inserts 2pcs.

Articulating Paper Holders

Articulating Paper Holder, M-Type



Description

It is made with milled in order not to move articulating paper and designed to be convenient for the operator.

[Specification]

Material : Stainless Steel

Size : 145mm

Product Code 06121000
Product Articulating Paper Holder, M-Type



(The inside)

Articulating Paper Holder, Y-Type



Description

Sure holding of Articulating papers by pins and holes. Ideal to make for full dentures.

[Specification]

Material : Stainless Steel

Size : Large 74 x 60mm Small 66 x 48mm

- Product Code** 06122000
- Product** Articulating Paper Holder, Y-Type, Large

- Product Code** 06122100
- Product** Articulating Paper Holder, Y-Type, Small



New Fine Lock Trays



Dry heat is prohibited

Description

"Retention rims" types. Brass , nickel plated . Complete with set of 8 size or individually each size .

Upper	mm			
	U11	U12	U13	U14
Wide	8 5	8 1	7 5	6 8
Depth	5 9	5 7	5 6	5 4
Height	1 9	2 0	2 0	2 1

Lower	mm			
	L11	L12	L13	L14
Wide	8 0	7 6	7 6	7 2
Depth	6 3	6 5	6 1	6 2
Height	2 1	2 1	2 2	2 3



- Product Code** 06040000
- Product** New Fine Lock Tray Assort (set of 8 pcs)

- Product Code** 06041011
- Product** New Fine Lock Tray #U11

- Product Code** 06041012
- Product** New Fine Lock Tray #U12

- Product Code** 06041013
- Product** New Fine Lock Tray #U13

- Product Code** 06041014
- Product** New Fine Lock Tray #U14

- Product Code** 06042011
- Product** New Fine Lock Tray #L11

- Product Code** 06042012
- Product** New Fine Lock Tray #L12

- Product Code** 06042013
- Product** New Fine Lock Tray #L13

- Product Code** 06042014
- Product** New Fine Lock Tray #L14

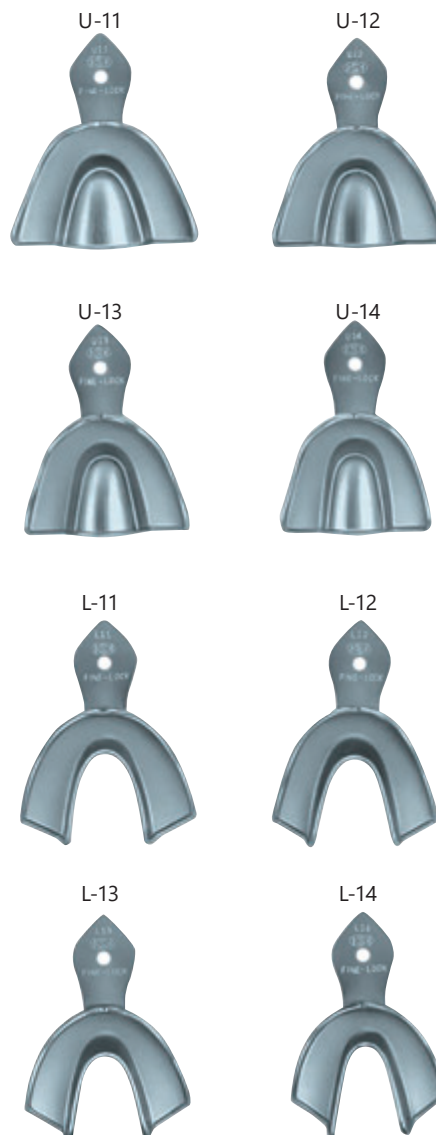

ENDODONTICS

PROSTHETICS

IMPLANTOLOGY

LABORATORY

MISCELLANEOUS



Twist Drills Black

Description

A surgical drill with increased abrasion resistance, corrosion resistance, durability and hardness with DLC coating. It comes with a movable stopper which allows for the length of the drill to be adjusted and a dedicated wrench. The adjustment range for the stopper is between 6 - 11mm for short, and 11 - 16mm for long.

What's DLC?

DLC is short for "Diamond Like Carbon", and it is technology that coats a nano - level hard film with properties that resemble that of diamonds onto metallic surfaces. While having approximately 5 times the hardness compared to existing products, it has shown overwhelming low friction factor and it is recognized as the most technologically advanced among the many surface treatment techniques available.

[Specification]
Material : Stainless steel

Product Code	30073000	Product	Twist Drill "Black" Short 2.0S
Product Code	30073010	Product	Twist Drill "Black" Short 2.6S
Product Code	30073020	Product	Twist Drill "Black" Short 2.8S
Product Code	30073030	Product	Twist Drill "Black" Short 2.9S
Product Code	30073040	Product	Twist Drill "Black" Short 3.0S
Product Code	30073050	Product	Twist Drill "Black" Short 3.1S
Product Code	30073060	Product	Twist Drill "Black" Short 3.2S
Product Code	30073070	Product	Twist Drill "Black" Short 3.3S
Product Code	30073080	Product	Twist Drill "Black" Short 3.4S
Product Code	30073090	Product	Twist Drill "Black" Short 3.5S
Product Code	30073100	Product	Twist Drill "Black" Short 3.6S
Product Code	30073110	Product	Twist Drill "Black" Short 3.7S
Product Code	30073120	Product	Twist Drill "Black" Short 3.8S
Product Code	30073130	Product	Twist Drill "Black" Short 4.0S
Product Code	30073140	Product	Twist Drill "Black" Short 4.2S
Product Code	30073150	Product	Twist Drill "Black" Short 4.5S
Product Code	30073160	Product	Twist Drill "Black" Long 2.0L
Product Code	30073170	Product	Twist Drill "Black" Long 2.8L
Product Code	30073180	Product	Twist Drill "Black" Long 3.1L
Product Code	30073190	Product	Twist Drill "Black" Long 3.2L
Product Code	30073200	Product	Twist Drill "Black" Long 3.3L
Product Code	30073210	Product	Twist Drill "Black" Long 3.5L
Product Code	30073220	Product	Twist Drill "Black" Long 3.8L



Short

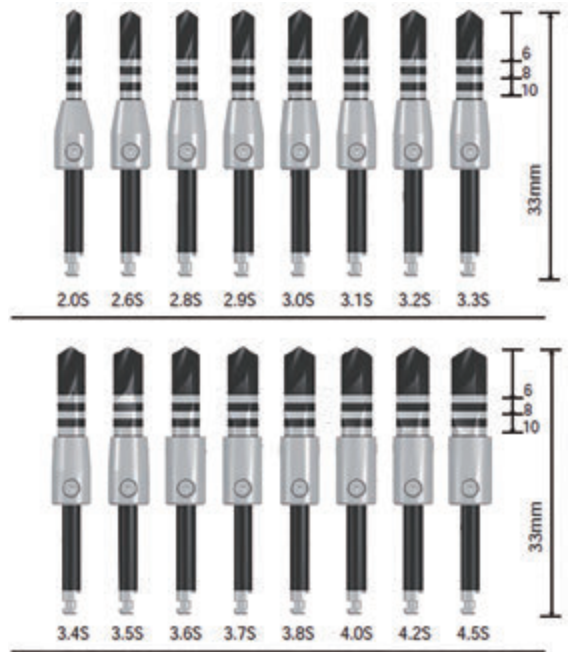

Long

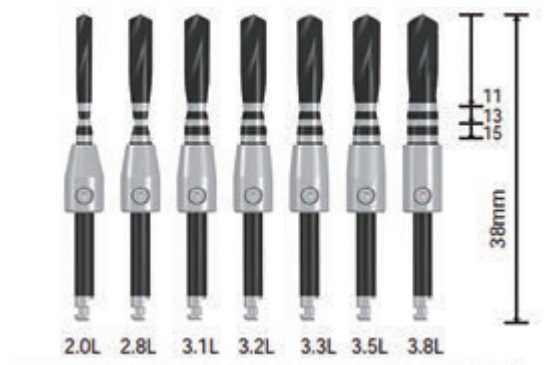

Step Drills For Guide

Description

Simplification of drill step has been made possible. It is ideal for pilot holes for tapered implants.

[Specification]

Material : Stainless steel



Product Code	30075000
Product	Step Drill "Black" for guide ϕ 2.4/2.8mm
Product Code	30075010
Product	Step Drill "Black" for guide ϕ 2.8/3.2mm
Product Code	30075020
Product	Step Drill "Black" for guide ϕ 3.2/3.6mm
Product Code	30075030
Product	Step Drill "Black" for guide ϕ 3.8/4.2mm
Product Code	30075040
Product	Step Drill "Black" for guide ϕ 4.2/4.6mm

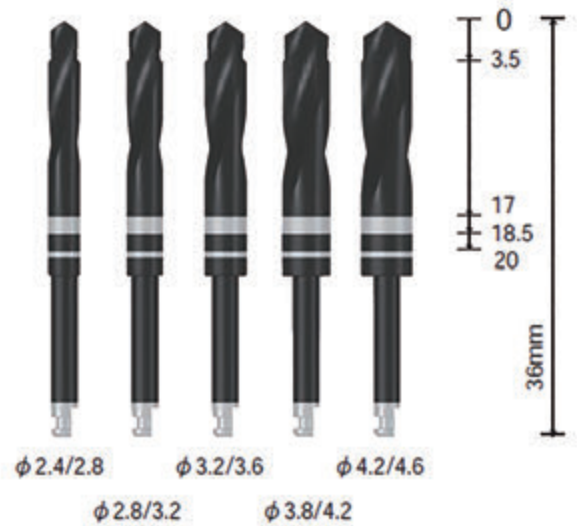

Twist Drills For Guide

Description

When using the 10mm surgical guide, it is marked to drill depths of 7mm, 8.5mm, 10mm.

[Specification]

Material : Stainless steel



Product Code	30074020
Product	Twist Drill "Black" for guide ϕ 2.0mm
Product Code	30074030
Product	Twist Drill "Black" for guide ϕ 3.0mm

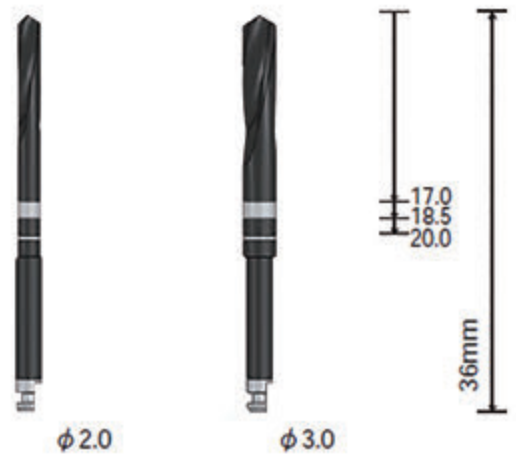

ENDODONTICS

PROSTHETICS

IMPLANTOLOGY

LABORATORY

MISCELLANEOUS



Twist Drills



Twist Drills External Cooling

Description

Our drills are made of stainless steel with high carbon. It assures enough hardness, good cutting efficiency and long life. But rather weak for rust. Careful maintenance will be required to avoid rust and to assure along life.

Good maintenance

- ① Immediately after use, drills should be dipped into anti-rust solution.
- ② Stopper should be removed while cleaning and autoclave.
- ③ Blood and bones should be removed completely after use.
- ④ Use only refined water for autoclave.
- ⑤ Use drill stand while autoclave, do not put into sterilization bag directly.



Product Code	30030200	Product	Twist Drill Short 2.0S
Product Code	30030280	Product	Twist Drill Short 2.8S
Product Code	30030310	Product	Twist Drill Short 3.1S
Product Code	30030320	Product	Twist Drill Short 3.2S
Product Code	30030330	Product	Twist Drill Short 3.3S
Product Code	30030350	Product	Twist Drill Short 3.5S
Product Code	30030380	Product	Twist Drill Short 3.8S
Product Code	30030400	Product	Twist Drill Short 4.0S
Product Code	30030420	Product	Twist Drill Short 4.2S

Product Code	30030450	Product	Twist Drill Short 4.5S
Product Code	30030550	Product	Twist Drill Short 5.5S
Product Code	30030201	Product	Twist Drill Long 2.0L
Product Code	30030281	Product	Twist Drill Long 2.8L
Product Code	30030311	Product	Twist Drill Long 3.1L
Product Code	30030321	Product	Twist Drill Long 3.2L
Product Code	30030331	Product	Twist Drill Long 3.3L
Product Code	30030351	Product	Twist Drill Long 3.5L
Product Code	30030381	Product	Twist Drill Long 3.8L

Twist Drills Internal Cooling

Description

The drills with internal cooling system should be used also with external cooling. Drill speed should be controlled from 600rpm(thick drills) up to 1000rpm(for fine drills).

Cutting efficiency is coming bad by each use and bad drill will cause heat damages against bone. Only good drills should be used for operation. For very hard bones, it is recommended to use surgical burs prior to implant drills. Surgical burs will help easy drilling and long life. The fix screw of drill stopper is so small and it can not be bear a strong force. Drills can be used also without stopper.

[Specification]

Material : Stainless steel

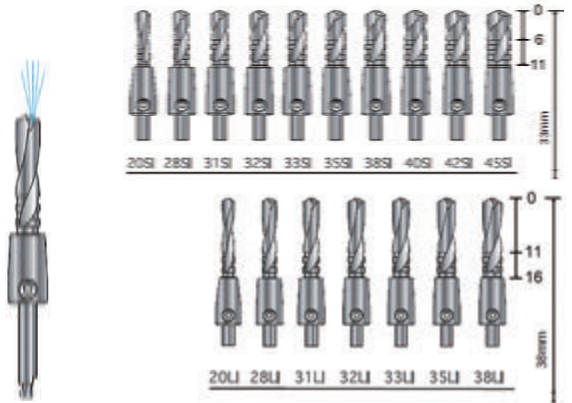

Product Code	30031200	Product	Twist Drill Short 2.0 SI
Product Code	30031280	Product	Twist Drill Short 2.8 SI
Product Code	30031310	Product	Twist Drill Short 3.1 SI
Product Code	30031320	Product	Twist Drill Short 3.2 SI
Product Code	30031330	Product	Twist Drill Short 3.3 SI
Product Code	30031350	Product	Twist Drill Short 3.5 SI
Product Code	30031380	Product	Twist Drill Short 3.8 SI
Product Code	30031400	Product	Twist Drill Short 4.0 SI
Product Code	30031420	Product	Twist Drill Short 4.2 SI
Product Code	30031450	Product	Twist Drill Short 4.5 SI

Product Code	30031201	Product	Twist Drill Long 2.0 LI
Product Code	30031281	Product	Twist Drill Long 2.8 LI
Product Code	30031311	Product	Twist Drill Long 3.1 LI
Product Code	30031321	Product	Twist Drill Long 3.2 LI
Product Code	30031331	Product	Twist Drill Long 3.3 LI
Product Code	30031351	Product	Twist Drill Long 3.5 LI
Product Code	30031381	Product	Twist Drill Long 3.8 LI
Product Code	30032000	Product	Screw for Implant Drill Stopper
Product Code	30032001	Product	Hexagonal Wrench for Implant Drill Stopper

Trephine Burs

Description

Trephine Burs do not have blade at center, thus it will be rather difficult to get smooth cutting for a start. Enough exercise is recommended before use. After Trephine Burs penetrate into bone, then smooth cutting is available. To avoid choking on bone inside Trephine Bur, pull of Trephine Burs up and down, so that bone will always remain at patient. Remained bone can be collected by surgical curettes. Enough cooling and possibly low speed is recommended to avoid heat damage against bone.

[Specification]

Material : Stainless steel

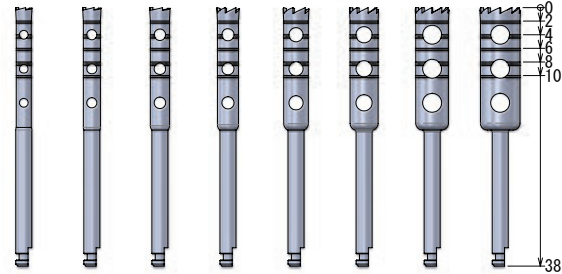

SIZE 2.4 2.7 3.0 3.3 3.8 4.3 5.0 6.0

Product Code 30060240 Product Trephine Bur 2.4

Product Code 30060270 Product Trephine Bur 2.7

Product Code 30060300 Product Trephine Bur 3.0

Product Code 30060330 Product Trephine Bur 3.3

Product Code 30060380 Product Trephine Bur 3.8

Product Code 30060430 Product Trephine Bur 4.3

Product Code 30060500 Product Trephine Bur 5.0

Product Code 30060600 Product Trephine Bur 6.0

Bone Trephines

Description

Bone Trephine is used for collection of big volume of bone. Enough exercise is recommended before use.

[Specification]

Material : Stainless steel

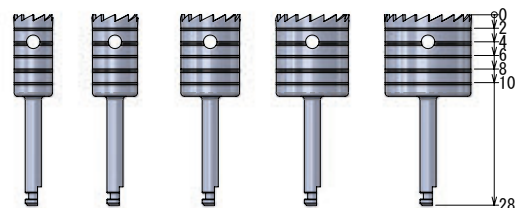

SIZE 5.0 6.0 8.0 10.0 12.0

Product Code 30070500 Product Bone Trephine 5.0

Product Code 30070600 Product Bone Trephine 6.0

Product Code 30070800 Product Bone Trephine 8.0

Product Code 30071000 Product Bone Trephine 10.0

Product Code 30071200 Product Bone Trephine 12.0

Circular Knives

Description

For cutting soft tissue. Use with very low speed or by finger. Complete with finger grip for each piece.

[Specification]

Material : Stainless steel

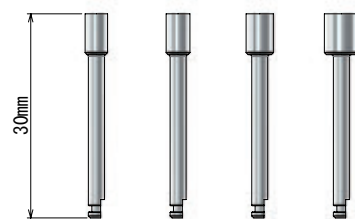

SIZE 3.3 3.5 4.0 5.0

Product Code 50010000 Product Circular Knife 3.3 without finger driver

Product Code 50010010 Product Circular Knife 3.5 without finger driver

Product Code 50010020 Product Circular Knife 4.0 without finger driver

Product Code 50010030 Product Circular Knife 5.0 without finger driver

Product Code 30051001 Product Finger Driver for Circular Knife



Surgical Burs



Surgical Bur External Cooling System

Description

- Round Burs
Round burs for bone cutting, ruff cutting edges to prevent clogging. Full group blades ensures excellent cutting efficiency.
- Dr. Lindemann Bur
Dr. Lindemann Bur has fully around blades.

Product Code	30011400	Product	Surgical Bur Round 141RF/010
Product Code	30011401	Product	Surgical Bur Round 141RF/014
Product Code	30011402	Product	Surgical Bur Round 141RF/018
Product Code	30011411	Product	Surgical Bur Round 141RF/025
Product Code	30011412	Product	Surgical Bur Round 141RF/031
Product Code	30011414	Product	Surgical Bur Round 141RF/040
Product Code	30011415	Product	Surgical Bur Round 141RF/050
Product Code	30011631	Product	Dr. Lindemann Bur 163RF/014
Product Code	30011641	Product	Dr. Lindemann Bur 164RF/018
Product Code	30011661	Product	Dr. Lindemann Bur 166RF/021

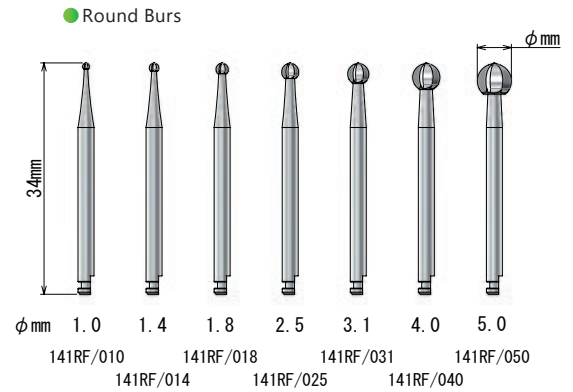

● Dr. Lindemann Bur

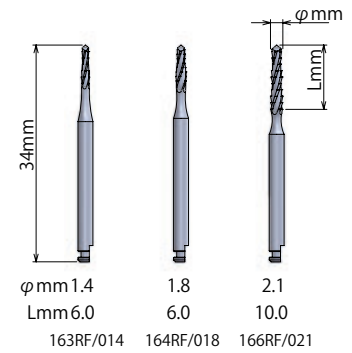

Surgical Bur Internal Cooling System

Description

These hully group surgical burs with internal cooling system enable very smooth cut and prevent heat damages for bone. Cooling fluid flow out blood thus operator can get clear view of operating spot. Prepare #40 K Reamers to clean internal cooling hold.

Product Code	30014711	Product	Surgical Bur Internal Cooling 471RF/023
Product Code	30011671	Product	Surgical Bur Internal Cooling 167RF/023
Product Code	30014731	Product	Surgical Bur Internal Cooling 473RF/031
Product Code	30014732	Product	Surgical Bur Internal Cooling 473RF/040
Product Code	30014733	Product	Surgical Bur Internal Cooling 473RF/050

● Round Burs

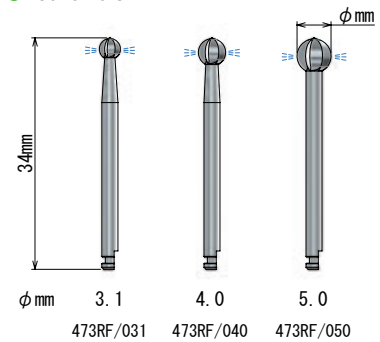

● Dr. Lindemann Bur

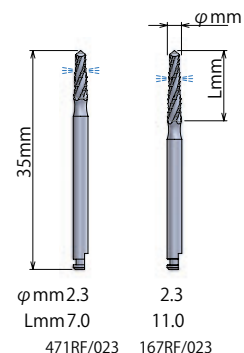



Technika TK Drill System

Description

Innovative dental drill for implant treatment.
 Safe and Secure drill systems
 Completed with a minimum 4drills, easy steps
 Ultra-low speed rotation, no water injection
 Autologous bone guide / Autologous bone collection

[Specification]

- Contents :**
- ① Surgical Bur Round 141RF/018
 - ② Twist Drill Short 2.0S (External Cooling)
 - ③ Technika TK Countersink (3.0, 3.5, 4.0, 4.5, 5.0)
 - ④ Technika TK Drill (φ 3.0, φ 3.5, φ 4.0, φ 4.5, φ 5.0)
 - ⑤ Technika Surgical Cassette *final drill is not included



Product Code 30120000 **Product** Technika TK Drill System

① Surgical Bur Round 141RF/018
 Material : Stainless Steel
 Length : 34 mm,
 Size : φ1.8mm
 Quantity : 1pc



③ Technika TK Countersink
 Material : Stainless Steel
 Length : 24 mm,
 Size : 3.0, 3.5, 4.0, 4.5, 5.0
 Quantity : 1pc each



② Twist Drill Short 2.0S (External Cooling)
 Material : Stainless Steel
 Length : 33 mm,
 Size : φ2.0
 Quantity : 1pc



④ Technika TK Drill
 Material : Stainless Steel
 Length : 36 mm,
 Size : φ3.0, φ3.5, φ4.0, φ4.5, φ5.0
 Quantity : 1pc each



⑤ Technika Surgical Cassette
 Material : Resin and Silicone
 Size : 99.5 mm x 143 mm x 61 mm
 Quantity : 1pc



● included drills



Multi-Adapter Wrench

Description

free-swing provides quick implantation.
 Conforms to major implant systems.

[Specification]

Material : Stainless steel.

- Product Code** 30080450 **Product** Multi-Adapter Wrench
- Product Code** 30080490 **Product** Replacement Driver
- Product Code** 30080500 **Product** Square Adapter
- Product Code** 30080550 **Product** HEX Adapter



Multi-Adapter Wrench



Square Adapter



Replacement Driver



HEX Adapter

ENDODONTICS

PROSTHETICS

IMPLANTOLOGY

LABORATORY

MISCELLANEOUS



Implant Drill Checker

Description

Can be measured diameter of 2.0 - 5.9mm.
Can be measured length of 6.0 - 18.0mm.
With length scale of 5 - 20mm. Can be used for drill stand.

[Specification]

Material : Stainless steel

Product Code 30080012

Product Implant Drill Checker

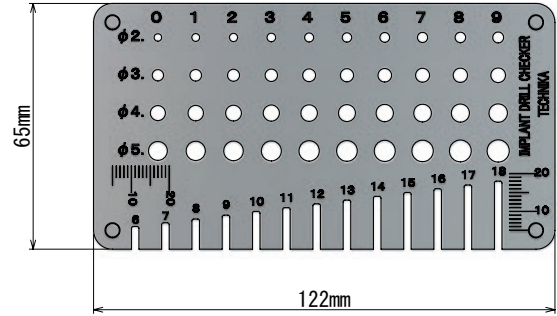

Drill Extenders

Description

Two types : External cooling/Internal cooling
Extension length : External cooling is 16.5mm,
Internal cooling is 18 mm.

[Specification]

Material : Stainless steel

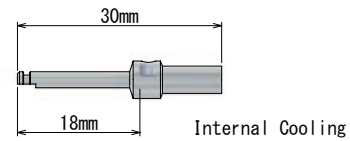
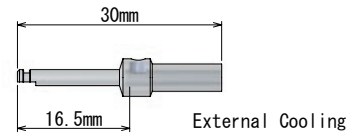

Product Code 30080001

Product Drill Extension External Cooling

Product Code 30080002

Product Drill Extension Internal Cooling

Drill Extension SHORT External Cooling

Description

Can extend the drill length slightly 5mm.
Easy attaching without tools.

[Specification]

Material : Stainless steel Diameter : 7.7 mm

Product Code 30079991

Product Drill Extension SHORT External Cooling



Technika Bone Mill Set

Description

- Simple and compact
- Easy operating
The angle mount enables easy and smooth operating.
- Easy milling
The unique shaped cutter with DLC coating enable easy and fine milling.
- Easy assembling
The simple structure saves time for operating and cleaning.

Product Code 30080015

Product Technika Bone Mill

Product Code 30080016

Product Replacement Cutter



Up to 121°C for 20 min
Dry heat is prohibited

Depth Gauges

Description

Graduations on 8, 10, 13, 15, 18, 20.
Graduations can be exposed on X-ray film.
Diameter : 1.3, 1.5, 1.9, 2.7, 3.0, 3.2, 3.4, 3.9mm.

[Specification]

Material : Stainless steel

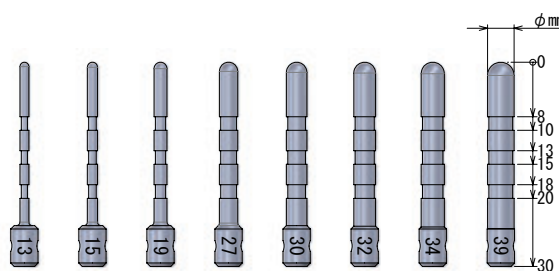

Product Code 30072130 Product Depth Gauge 1.3

Product Code 30072150 Product Depth Gauge 1.5

Product Code 30072190 Product Depth Gauge 1.9

Product Code 30072270 Product Depth Gauge 2.7

Product Code 30072300 Product Depth Gauge 3.0

Product Code 30072320 Product Depth Gauge 3.2

Product Code 30072340 Product Depth Gauge 3.4

Product Code 30072390 Product Depth Gauge 3.9

ENDODONTICS

PROSTHETICS

IMPLANTOLOGY

LABORATORY

MISCELLANEOUS



Technika Repair Tap

Description

- For internal threads repair.
- Made of high corrosion resistant stainless steel compatible with autoclave.
- Long lasting DLC coating.
- Safe Handle

[Specification]

Material : Stainless steel (Tap and Handle)
 Surface Treatment : DLC coating (Tap)
 Thread Diameter x Pitch : M1.6 x 0.35 / M2.0 x 0.4
 Made in Japan

Product Code	30011110	Product	REPAIR TAP M1.6 with Handle
Product Code	30011130	Product	REPAIR TAP M2.0 with Handle
Product Code	30011210	Product	M1.6 Tap only
Product Code	30011230	Product	M2.0 Tap only
Product Code	30011300	Product	Handle for Repair Tap

- Repair Tap with Handle(Basic Set)



- Repair Tap



For users having "Handle"

- Handle for Repair Tap



Compatible to both Tap

SCREW REMOVER

Description

- For removal of broken abutment screw.
- Made of high corrosion resistant stainless steel compatible with autoclave.
- Safe Handle

[Specification]

Material : Stainless steel (Remover and Handle)
 Length : S : 24mm / L : 32mm (For M1.6 and M2.0)
 Thread Diameter x Pitch : M1.6 x φ1.1mm / M2.0 x φ1.4mm

Product Code	30010910	Product	M1.6 L with Handle
Product Code	30010915	Product	M1.6 S with Handle
Product Code	30010930	Product	M2.0 L with Handle
Product Code	30010935	Product	M2.0 S with Handle
Product Code	30011010	Product	M1.6 L Screw Remover only
Product Code	30011015	Product	M1.6 S Screw Remover only
Product Code	30011030	Product	M2.0 L Screw Remover only
Product Code	30011035	Product	M2.0 S Screw Remover only
Product Code	30011300	Product	Handle for Screw Remover

- Screw Remover with Handle(Basic set)



- Screw Remover



- Handle for Screw Remover



Compatible to both Tap

Gingiva Gauge

Description

The first division shows 1mm when top of measuring block and needle are coincide. Wide of graduation is 1mm and pitch is 2mm, thus each graduation shows the gingival thickness of 2, 3, 4, 5, 6, 7mm. Put the measuring block in right angle to gingiva, then prick gingiva by light force until needle reaches to bone. Pull out carefully so that measuring block would not moves. Read the thickness at the back side of measuring block.

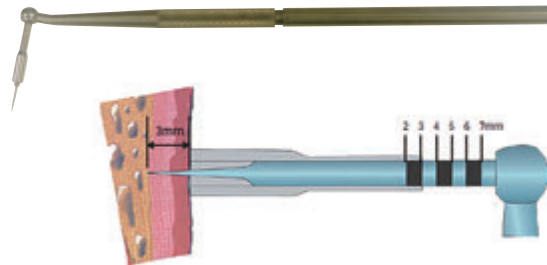

Product Code 30080013 Product Gingiva Gauge

- Can be measured the thickness of gingiva from 2mm to 7mm in increments of 1mm during implant operation.
- For a more exact and detailed measure. It is better to use micrometer caliper separately.

ENDODONTICS

PROSTHETICS

IMPLANTOLOGY

LABORATORY

MISCELLANEOUS

Bur Stands

Description

You can stand 6 burs.

[Specification]

Material : Stainless Steel

Bur Stand 40(w70 x D40 x H15mm) Compliant bur length : Max 35mm

Bur Stand 45(W70 x D45 x H15mm) Compliant bur length : Max 40mm

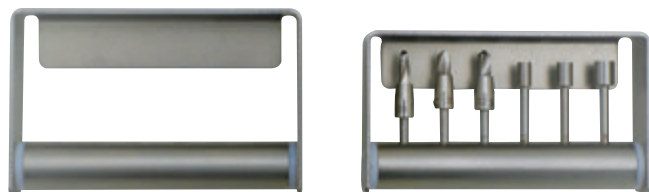

Product Code 30080010 Product Bur Stand 40

Product Code 30080011 Product Bur Stand 45



Vulcanite Burs

[Specification]

Material : Stainless Steel

Large and small types are available.

Large : Maximum diameter is 6 mm.

Small : Maximum diameter is 4.8 mm.

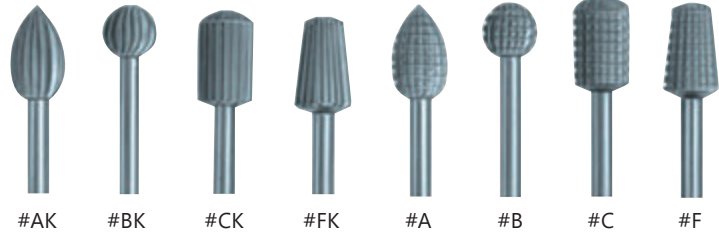

※ Straight hand piece type only.

Product Code	02101011	Product	Vulcanite Burs #A, LARGE	Product Code	02111011	Product	Vulcanite Burs #AK, LARGE
Product Code	02101012	Product	Vulcanite Burs #A, SMALL	Product Code	02111012	Product	Vulcanite Burs #AK, SMALL
Product Code	02101021	Product	Vulcanite Burs #B, LARGE	Product Code	02111021	Product	Vulcanite Burs #BK, LARGE
Product Code	02101022	Product	Vulcanite Burs #B, SMALL	Product Code	02111022	Product	Vulcanite Burs #BK, SMALL
Product Code	02101031	Product	Vulcanite Burs #C, LARGE	Product Code	02111031	Product	Vulcanite Burs #CK, LARGE
Product Code	02101032	Product	Vulcanite Burs #C, SMALL	Product Code	02111032	Product	Vulcanite Burs #CK, SMALL
Product Code	02101061	Product	Vulcanite Burs #F, LARGE	Product Code	02111061	Product	Vulcanite Burs #FK, LARGE
Product Code	02101062	Product	Vulcanite Burs #F, SMALL	Product Code	02111062	Product	Vulcanite Burs #FK, SMALL

Air Jet Diamonds

Features

Air Jet Diamond have air slits at cutting head, the slits supply strong air while cutting.

The strong air flow prevent the clogging of cutting materials.

Thus, you can very smoothly and effective cutting.



Product Code	02091001	Product	Air Jet Diamonds #1
Product Code	02091002	Product	Air Jet Diamonds #2
Product Code	02091003	Product	Air Jet Diamonds #3
Product Code	02091010	Product	Air Jet Diamonds #1A
Product Code	02091011	Product	Air Jet Diamonds #2A

		Head Size
#1A		Φ1.2
#1		Φ2.0
#2A		Φ3.1
#2		Φ4.8
#3		Φ6.0



Lip & Cheek Retractor

Features

To retractor cheeks and to have a better view.

[Specification]

Material : Polycarbonate Set of 2pcs

Product Code 50570131 Product Lip & Cheek Retractor Set



Dry heat is prohibited

Lip Expanders

Features

Superb anterior access. Available in an adult, child or assorted(adult / child)set.

- Soft, plastic frame.
- Comfortable for the patient.
- Provides excellent anterior access.

[Specification]

Material : Polypropylene

Product Code 50570010 Product Lip Expander Adult Size (set of 2 pcs)

Product Code 50570011 Product Lip Expander Child Size (set of 2 pcs)

Product Code 50570020 Product Lip Expander Adult & Child, (set of 2 pcs)

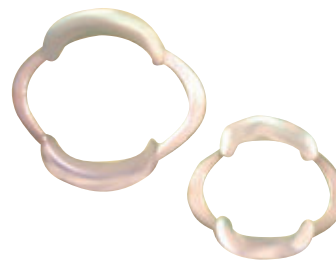

Dry heat is prohibited

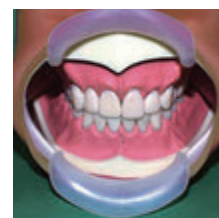

ENDODONTICS

PROSTHETICS

IMPLANTOLOGY

LABORATORY

MISCELLANEOUS



Big Oral Mirrors Real-Fine

Features

- Ideal for distortion - free intra - oral photos.
- Extensive rhodium coating on one side.
- Sturdy, durable.
- With detachable silicone handle.
- Autoclavable in the provided fabric bag.
- Reflection rate : 73%

#1 : Side views. #2 : Occulusal views (medium). #3 : Occulusal views (large).

#4 : For lingual side views of posteriors.

#5 : For lingual side views of anteriors. Handle for #4 , #5 : aluminum.

Big Oral Mirror Set : Assort of #1,#2 and #3

Product Code	07000100
Product	Big Oral Mirror Set (#1~#3)
Product Code	07000101
Product	Big Oral Mirror #1
Product Code	07000102
Product	Big Oral Mirror #2
Product Code	07000103
Product	Big Oral Mirror #3
Product Code	07000104
Product	Silicone Handle for Big Oral Mirror
Product Code	07000105
Product	Big Oral Mirror #4
Product Code	07000106
Product	Big Oral Mirror #5
Product Code	07000109
Product	Aluminium Handle for Big Oral Mirror



Handle : Dry heat is prohibited

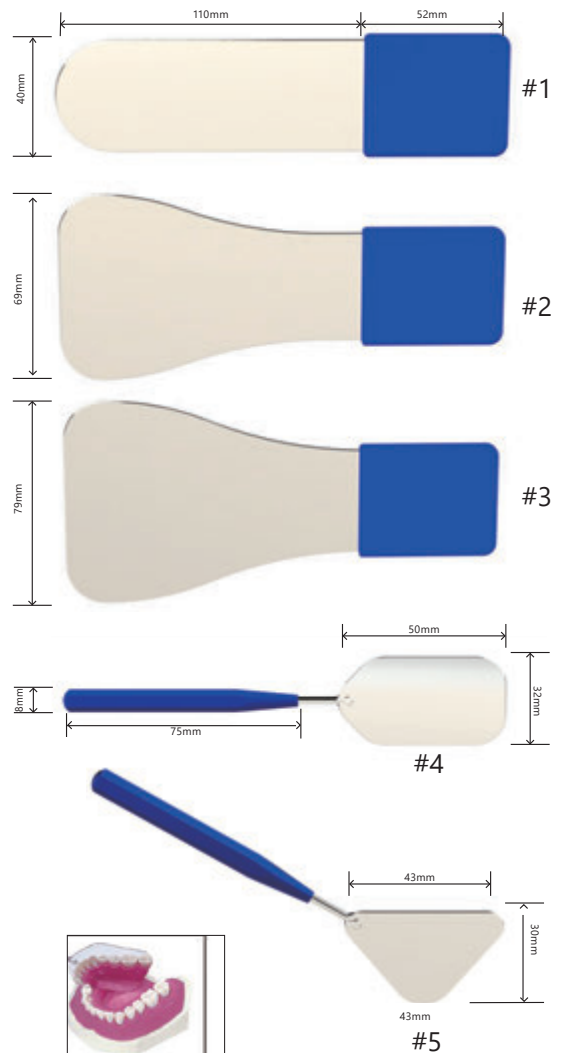

Cotton Pliers



Description

Available for picking up 0.01g.

[Specification]

Coak type Material : Stainless steel Size : 162mm

Product Code 06301010

Product Cotton Plier

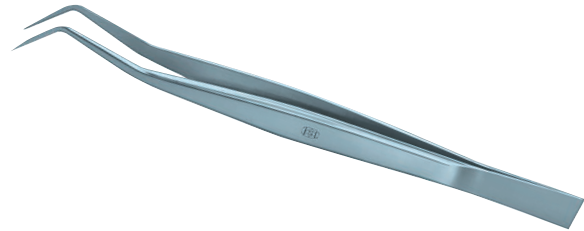

Tongue Guards & Saliva Ejector



Description

Three different sizes metal reflectors are changeable and they protect tongue from turbine.

[Specification]

Pipe : brass , chrome plated Others : Stainless steel Size : 138 x 80mm

Product Code 50050010

Product Tongue Guards & Saliva Ejector



MOQ : 100pcs. Please contact us about the price every order.

Parallel Reflector



Features

Mirror with parallel lines.
Autoclavable.

[Specification]

Coak type Material : Stainless steel
Size : H 18 x W 48 mm, Thread Part M2.5 (P=0.45 L-5)

Product Code 50050100

Product Parallel Reflector

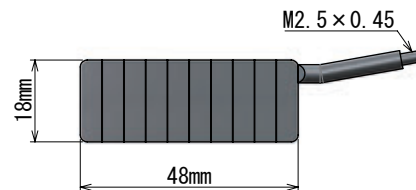

MOQ : 100 pcs

ENDODONTICS

PROSTHETICS

IMPLANTOLOGY

LABORATORY

MISCELLANEOUS



MISCELLANEOUS

ENDODONTICS

PROSTHETICS

IMPLANTOLOGY

LABORATORY

MISCELLANEOUS

pinlight2

Features

- The mirror and the light guide are detachable and autoclavable.
- The handle is IP X7 waterproof and capable of alcohol disinfection.
- Much brighter 90lm White LED Lighting used for detecting caries.
- Roder's HR FRONT mirror comes with size 4.

[Specification]

Light : 90LM, Cool white LED

Mirror : HR FRONT coating, size 4

Battery : Two AAA-size

Waterproof Performance IPX7 JIS C 0920 (IEC 60529)

Continuous lighting time : 90 min

Product Code	30080350
Product	pinlight2
Product Code	30080420
Product	Mirror holder, set of 4pcs.
Product Code	30080360
Product	Light guide
Product Code	30080370
Product	Replacement O ring, set of 3pcs.



Handle



Light guide
Mirror top



Dry heat is prohibited
Mirror holder



Mirror top No.4 included

Excavators



Features

special hollow octagon handle which enables very light weight as well as ideal balance.
high cutting performance and long life.

[Specification]

Material : Stainless Steel Size : 165 mm x Handle : 5.8 mm

Product Code 50581100 Product Excavators #19/20

Product Code 50581150 Product Excavators #21/22

#19/20



#21/22



MOQ : 100 pcs

Wax Spatulas #7A

[Specification]

Material : Stainless Steel Size : 150 mm x Handle : 4.5 mm

Product Code 50581020 Product Wax Spatulas #7A



MOQ : 100 pcs

ENDODONTICS

PROSTHETICS

IMPLANTOLOGY

LABORATORY

MISCELLANEOUS



ENDODONTICS

PROSTHETICS

IMPLANTOLOGY

LABORATORY

MISCELLANEOUS

Evans

[Specification]

Material : Spoon Stainless Steel, Handle Aluminum Size : 171 mm x Handle : 8 mm

Product Code 50581000 Product Evans



MOQ : 100 pcs

Hollenback #3

[Specification]

Material : Stainless Steel Size :166 mm x Handle : 5.8 mm

Product Code 50581040 Product Hollenback #3



MOQ : 100 pcs

Plastic Filling Instruments, Woodson #1

[Specification]

Material : Stainless Steel Size : 174 mm x Handle : 5.8 mm

Product Code 50581060 Product Plastic Filling Instruments, Woodson #1



MOQ : 100 pcs

DENTECH Corporation (copyright, all rights reserved).

The Catalogue is intended to the practicing dentists, students of the medical universities and colleges, dental trade dealers. Design of the Catalogue, together with all the images, texts, graphic elements, text markers and identifiers are intellectual property of our company. For partial or full copying or loaning of any of the above mentioned elements for commercial purposes, you are obliged to ask for it and receive written permission.

Catalogue is for information only. The company does not carry any liability for possible miss prints, text mistakes or difference in products' colour or form of the items pictured on the images. The company leaves its' right for changes without prior consent.



History of DENTECH

In 1907, Dentech Corporation, a pioneering manufacturer in Dental Instruments, was founded in Yanaka, Tokyo by Kenjiro Kimura, and it was originally named as Kimura Kousakusho.

We manufactured the first Japan made dental burs.

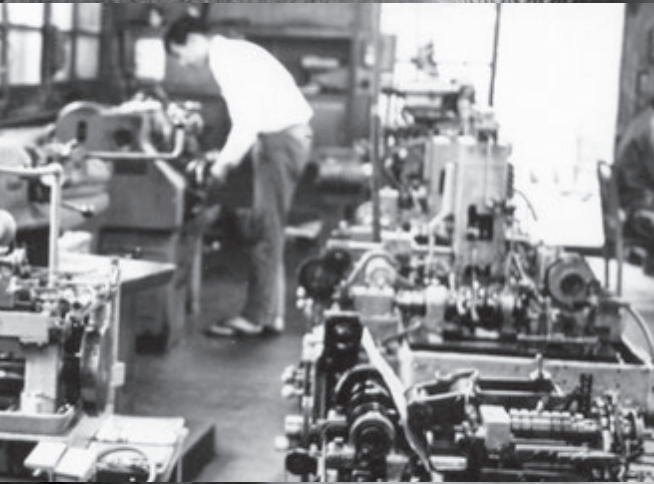

After Second World War

In 1944, the first factory was destroyed due to Second World War. In 1947, after the war, we transferred our factory to Itabashi in Tokyo and reconstructed it.

However, in 1954, the strongest ever typhoon unfortunately struck around the area and the factory collapsed again.

In 1955, we rebuilt a new factory at the place nearby the destroyed factory to continue providing our products for the customers.



First Advancement Overseas

After Second World War, a lot of dentists came to Japan from the U.S. accompanying the occupation army and needed trustworthy dental instruments with high quality.

Thus we were able to develop our products through the cooperation of them.

In 1971, we launched to export our products overseas and our first overseas customer was in the United States.

Renamed as DENTECH

Kimura Kosakusho was renamed as Dentech Corporation in 1974. Since 1976 we have manufactured drills for implantology as the first implant drill manufacturer in Japan.

Nowadays most Japanese implant makers adopt our drills.

The Current DENTECH

Today Dentech is well known as one of the companies which have the longest over 100 - year history in dental industry.

KSK rubber dam instruments, implantation drills and burs as well as many unique products with Japan-made high quality are well supported by dentists and professionals all over the world.

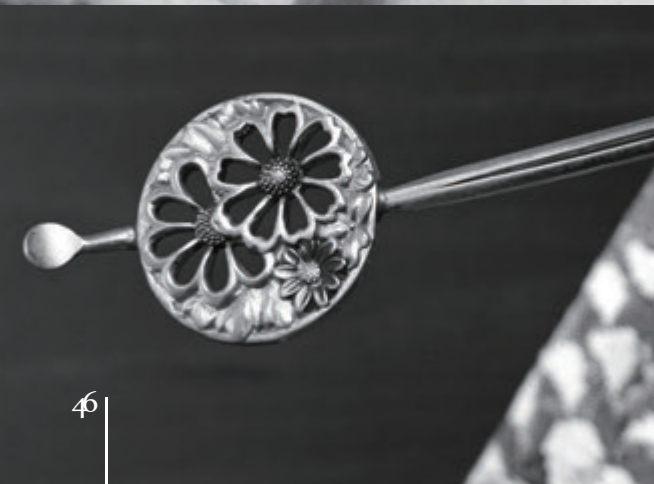

Joint Performance with Japanese CRAFTSMANSHIP and Latest Machine Technologies



We possess CNC lathe, CNC Grinding machine, Heat treating machine, 3D CAD/CAM systems, and other various latest machines and equipments at our own factory in Japan. At the same time we are proud of the greatest technique by our craftsmen whose skill is unequalled with any others. We have an advantage in manufacturing extremely delicate dental/medical instruments using these two wheels which are identified by the machine automation and craftsmen's technique.

We have been developing, designing and manufacturing any kinds of dental and surgical instruments needed in clinical site around the world with outstanding quality for over a century.

It is a great honor for us that our products are highly respected all over the world. Our products would surely satisfy you.

Dentech has been assessed and certified as meeting the requirements of ISO 13485.

KSK Rubberdam system's products verified by the European medical device regulation, UK regulation and USA regulation.

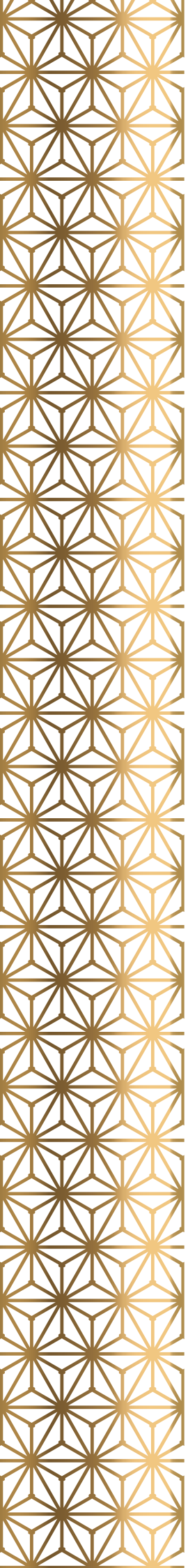

WEBSITE



e-CATALOGUE